

Ergotron® LX

Desk Mount LCD Arm

Dimensional & Range of Motion Illustrations

Dimensions

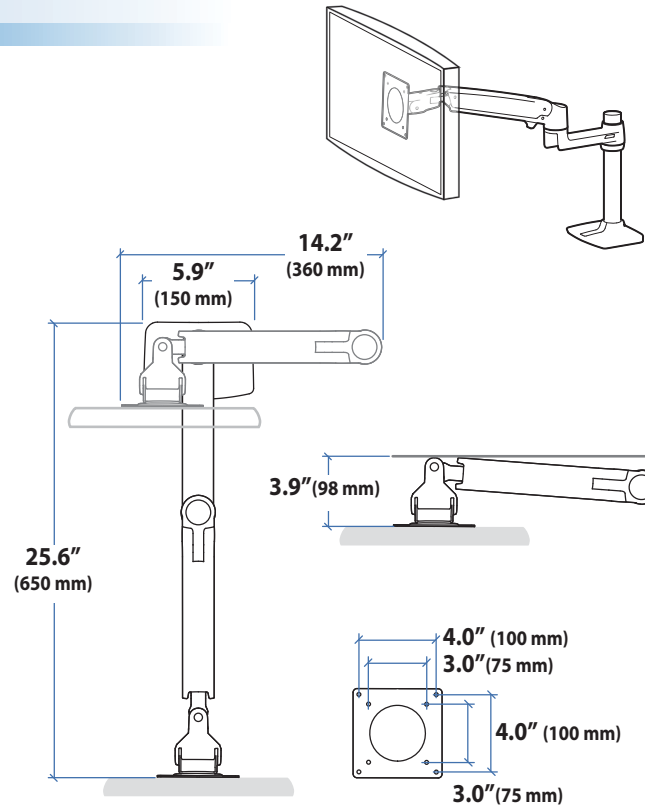
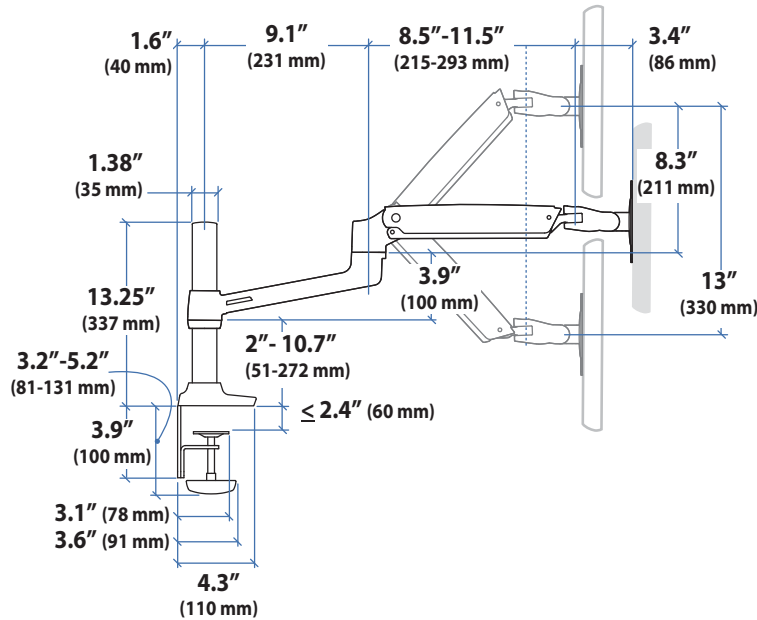

Desk Clamp

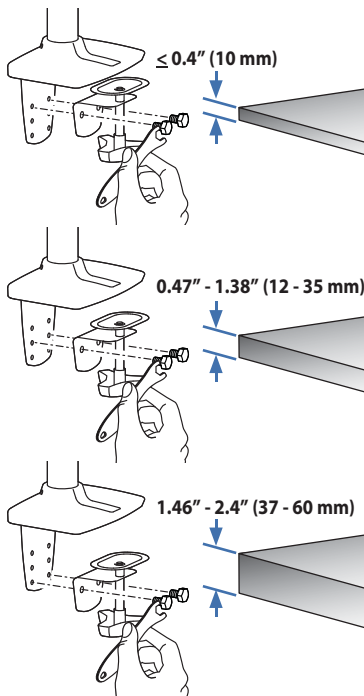

Grommet Mount

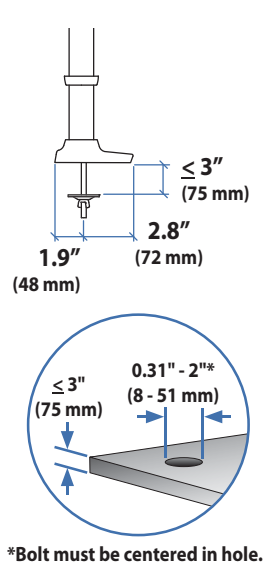

© 2011 Ergotron, Inc. rev. 10/31/2011 DIM-056-TallPole Content is subject to change without notification

Americas Sales and Corporate Headquarters

St. Paul, MN USA
 (800) 888-8458
 +1-651-681-7600
 www.ergotron.com
 sales@ergotron.com

EMEA Sales

Amersfoort, The Netherlands
 +31 33 45 45 600
 www.ergotron.com
 info.eu@ergotron.com

APAC Sale

Tokyo, Japan
 www.ergotron.com
 apaccustomerservice@ergotron.com

Worldwide OEM Sales

www.ergotron.com
 info.oem@ergotron.com



Ergotron® LX

Desk Mount LCD Arm

Dimensional & Range of Motion Illustrations

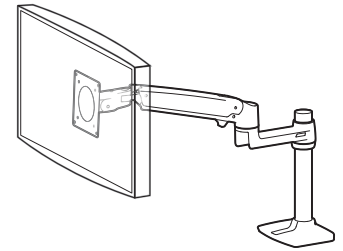

Range of Motion

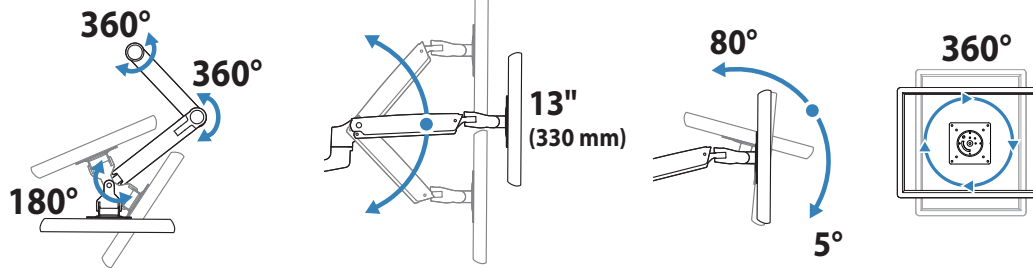

Weight Capacity

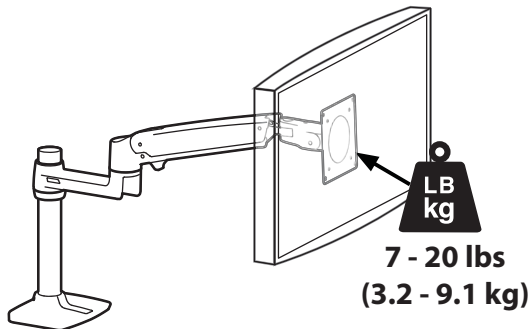

Monitor depth greater than 2.5" (64 mm) may diminish capacity.
Call Ergotron for more information.

© 2011 Ergotron, Inc. rev. 10/31/2011 DIM-056-TallPole Content is subject to change without notification

Americas Sales and Corporate Headquarters

St. Paul, MN USA
(800) 888-8458
+1-651-681-7600
www.ergotron.com
sales@ergotron.com

EMEA Sales

Amersfoort, The Netherlands
+31 33 45 45 600
www.ergotron.com
info.eu@ergotron.com

APAC Sale

Tokyo, Japan
www.ergotron.com
apaccustomerservice@ergotron.com

Worldwide OEM Sales

www.ergotron.com
info.oem@ergotron.com

